

Switches

LTHS17006SA00

Type	LTHS 1700
Number of Poles	6 NO (2x3 NO)
Mounting Position	Horizontal - Vertical
Control Voltage Rating [V _{dc}]	24 ÷ 220
Auxiliary Contact Blocks	Max 4 x (1 NO + 1 NC or 2 NO)
Block Type*	SL
Arc chute Material	Ceramic
Contact Tips Material*	S4 - S6

* For details please refer to dedicated technical note

Description

Contactor with single interruption in air, electromagnetic control by power save system. Single state functioning. Reference standard IEC 60077.

Electrical Characteristics

Rated Operational Voltage [V _{ac} / V _{dc}]	1500
Max Operational Voltage [V _{ac} / V _{dc}]	2000
Rated Insulation Voltage [V]	2000
Conventional Free Air Thermal Current [A] at 75°C	4500
DC-Rated Operational Current (τ=15ms) [A]	
1500V	2860
750V	5720
DC-Maximum Breaking Capacity (τ=15ms) [A]	
1500V	3500
750V	7000
AC-Maximum Breaking Capacity (cosφ=0,8; 50Hz) [A]	
1500V	4000
750V	8000
Short Circuit Withstand Capacity for 5ms [kA]	36
Critical Current Range [A]	<30 at 1500V _{dc}
Fault Making Capacity [kA]	27
Component Category / Operational Frequency Class	A2 / C3
Blow Out Circuit Type	Indirect

Minimum clearances
from metal parts [mm]
X = 80; Y = 300; Z = 40

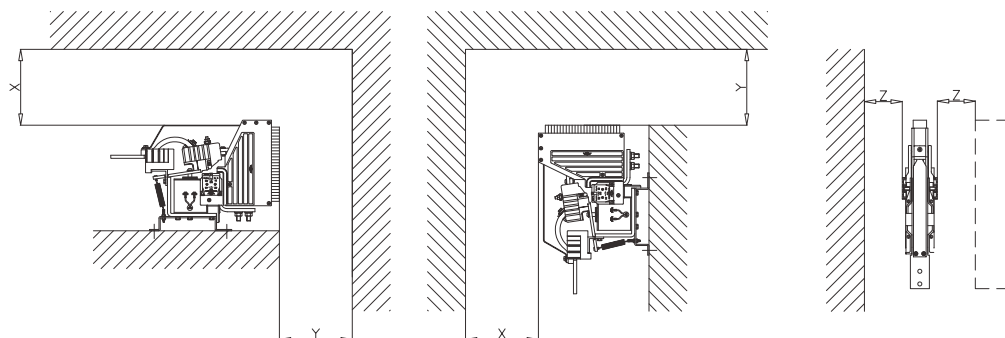

Switches

LTHS17006SA00

Mechanical Characteristics

Mechanical Endurance (cycles)	2x10 ⁶
Shock and Vibrations (IEC61373)	Cat.1 - Class B
Weight [kg]	120

Control Circuit

Control Voltage Range	0.7U _c ÷ 1.25U _c
Power Consumption (U _c and T = 20°C) at Pick Up - when Holding [W]	120 - 120
Mechanical Operation Time (U _c and T = 20°C) when Closing - Opening [ms]	300 - 60
Time Constant (L/R) at Pick Up - when Holding [ms]	460 - 380
Electrical Connections	Fast-On 6.35x0.8mm - Screw M4

Auxiliary Contacts

Tips material	Ag/Au
Rated Operational Voltage [V _{ac} / V _{dc}]	250
Rated Current [A]	10
Minimum Switching Current at 16V _{dc} [mA]	20
Electrical Connections	Fast-On 6.35x0.8mm - Screw M4

Environmental Conditions

Stock Temperature Range	-50°C ÷ +85°C
Operational Temperature Range	-40°C ÷ +75°C
Pollution Degree - Overvoltage Category (EN 50124-1)	PD3 / OV3
Max Altitude without Performance Derating [m]	1500